

**REPUESTOS DE PARA FUMIGADORA 37CC /
SPARE PARTS FOR 37CC FUMIGADORA
(MODELO /MODEL : BON-P-KS37)**

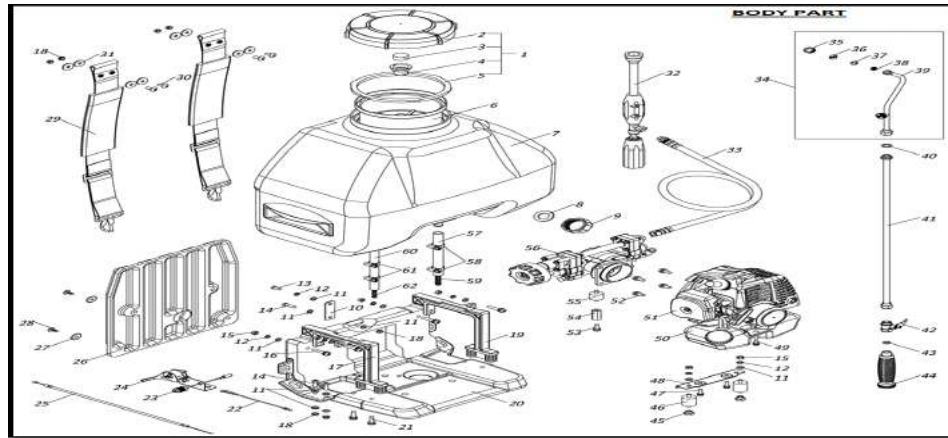

















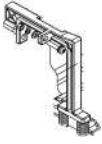

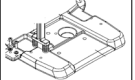



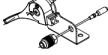

PARTES DEL CUERPO (BODY PARTS)











S.NO.	ERP - CODE	BONHOEFFER CÓDIGO	PRODUCTO IN SPANISH	PRODUCTO IN ENGLISH	FOTO DE EMBALAJE	CANTIDAD REQUERIDA
-------	------------	-------------------	---------------------	---------------------	------------------	--------------------















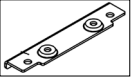





1	NA	BONKS37-B01	CONJUNTO DE TAPA DEL TANQUE (INCLUYE 2 A 5)	TANK LID ASSY (INCLUDE 2 TO 5)		
2	NA	BONKS37-B02	TAPA DE LA CAJA DEL TANQUE	TANK BOX COVER		
3	NA	BONKS37-B03	ESPONJA TRANSPIRABLE	BREATHABLE SPONGE		
4	NA	BONKS37-B04	TAPÓN DE VENTILACIÓN	VENT PLUG		
5	NA	BONKS37-B05	JUNTA DE LA TAPA DE LA CAJA DEL TANQUE	TANK BOX COVER GASKET		
6	NA	BONKS37-B06	FILTRO BOCA CAJA TANQUE	TANK BOX MOUTH FILTER		
7	NA	BONKS37-B07	COFRE DEL TANQUE	TANK CHEST		

8	NA	BONKS37-B08	JUNTA DEL TAPÓN DE DRENAJE	DRAIN PLUG GASKET		
9	NA	BONKS37-B09	TAPÓN DE DRENAJE	DRAIN CAP		
10	NA	BONKS37-B10	PIEZA DE FIJACIÓN DEL CAÑÓN	BARREL FIXING PIECE		
11	NA	BONKS37-B11	LAVADORA 6	WASHER 6		
12	NA	BONKS37-B12	ARANDELA DE RESORTE 6	SPRING WASHER 6		
13	NA	BONKS37-B13	TORNILLO PHILLIPS PEQUEÑO DE CABEZA TRONCOCÓNICA M6×12	PHILLIPS SMALL PAN HEAD SCREW M6×12		
14	NA	BONKS37-B14	TORNILLO PHILLIPS PEQUEÑO DE CABEZA TRONCOCÓNICA M6×20	PHILLIPS SMALL PAN HEAD SCREW M6×20		
15	NA	BONKS37-B15	TUERCA HEXAGONAL M6	HEX NUT M6		
16	NA	BONKS37-B16	TORNILLO COMBINADO DE CABEZA TRONCOCÓNICA EMPOTRADO EN CRUZ M6×30	CROSS RECESSED PAN HEAD COMBINATION SCREW M6×30		
17	NA	BONKS37-B17	TORNILLO COMBINADO DE CABEZA TRONCOCÓNICA EMPOTRADO EN CRUZ M6×30	CROSS RECESSED PAN HEAD COMBINATION SCREW M6×30		
18	NA	BONKS37-B18	INSERTO NO METÁLICO HEX LOCK TUERCA DELGADA M6	NON-METALLIC INSERT HEX LOCK THIN NUT M6		
19	NA	BONKS37-B19	MARCO DE SOPORTE DERECHO	RIGHT SUPPORT FRAME		
20	NA	BONKS37-B20	BASE	BASE		

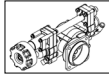
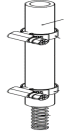
21	NA	BONKS37-B21	TORNILLO COMBINADO DE CABEZA TRONCOCÓNICA EMPOTRADO EN CRUZ M6x25	CROSS RECESSED PAN HEAD COMBINATION SCREW M6x25		
22	NA	BONKS37-B22	DETENER EL CABLE	STOP CABLE		
23	NA	BONKS37-B23	BOTÓN DETENER	STOP BUTTON		
24	NA	BONKS37-B24	CONJUNTO DE PALANCA Y ASIENTO.	LEVER AND SEAT ASSY.		
25	NA	BONKS37-B25	CABLE DEL ACELERADOR	THROTTLE CABLE		
26	NA	BONKS37-B26	ALMOHADILLA TRASERA	BACK PAD		
27	NA	BONKS37-B27	ARANDELA SOBREDIMENSIONADA DE LA ALMOHADILLA TRASERA	BACK PAD OVERSIZED WASHER		
28	NA	BONKS37-B28	ARANDELA SOBREDIMENSIONADA DE LA ALMOHADILLA TRASERA	BACK PAD OVERSIZED WASHER		
29	NA	BONKS37-B29	CONJUNTO DE CORREA	STRAP SET		
30	NA	BONKS37-B30	TORNILLO DE CABEZA PLANA EMPOTRADO EN CRUZ M6x14	CROSS RECESSED FLAT HEAD SCREW M6x14		
31	NA	BONKS37-B31	TORNILLO DE CABEZA PLANA EMPOTRADO EN CRUZ M6x14	CROSS RECESSED FLAT HEAD SCREW M6x14		
32	NA	BONKS37-B32	PISTOLA ROCIADORA	SPRAY GUN		
33	NA	BONKS37-B33	MANGUERA DE PULVERIZACIÓN	SPRAY HOSE		

34	NA	BONKS37-B34	CONJUNTO DE BOQUILLA DE VENTILADOR (INCLUYE 35-39)	FAN NOZZLE ASSY (INCLUDE 35-39)		
35	NA	BONKS37-B35	TUERCA DE BOQUILLA	NOZZLE NUT		
36	NA	BONKS37-B36	PLACA DE PULVERIZACIÓN	SPRAY PLATE		
37	NA	BONKS37-B37	ARANDELA DE SELLADO	SEAL WASHER		
38	NA	BONKS37-B38	FILTRO DE BOQUILLA	NOZZLE FILTER		
39	NA	BONKS37-B39	TUBO DE POSTE DE DOS ORIFICIOS	TWO-HOLE POLE TUBE		
40	NA	BONKS37-B40	ARANDELA DE SELLO 11x16x2	SEAL WASHER 11x16x2		
41	NA	BONKS37-B41	LANZA PULVERIZADORA	SPRAY LANCE		
42	NA	BONKS37-B42	GRIFO DE BOLA BC-303	BALL COCK BC-303		
43	NA	BONKS37-B43	ARANDELA DE SELLO 7x12x2	SEAL WASHER 7x12x2		

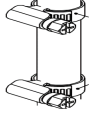





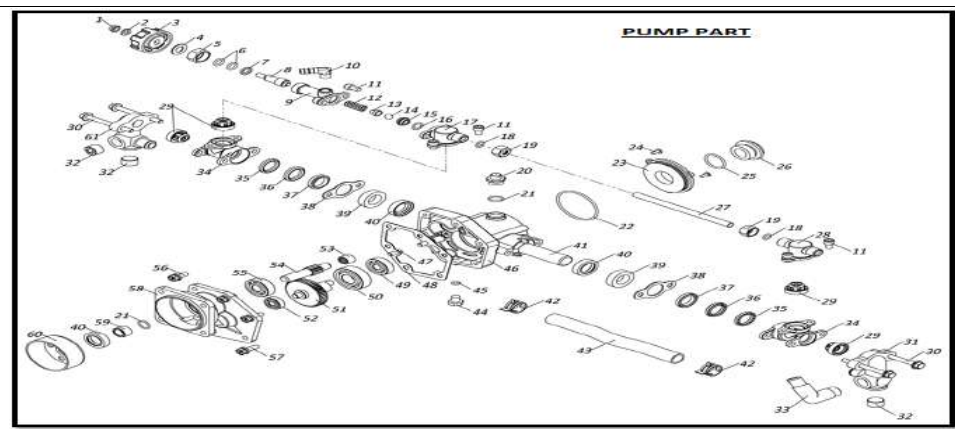

44	NA	BONKS37-B44	RESOLVER	HANDLE		
45	NA	BONKS37-B45	TUERCA DE ARANDELA DE ESQUINA TRASERA	REAR CORNER WASHER NUT		
46	NA	BONKS37-B46	ALMOHADILLA AMORTIGUADORA (ALTURA 30)	SHOCK-ABSORBING PAD (HEIGHT 30)		
47	NA	BONKS37-B47	TORNILLO COMBINADO DE CABEZA TRONCOCÓNICA EMPOTRADO EN CRUZ M5x20	CROSS RECESSED PAN HEAD COMBINATION SCREW M5x20		
48	NA	BONKS37-B48	SOPORTE DE MONTAJE DEL MOTOR	ENGINE MOUNTING BRACKET		
49	NA	BONKS37-B49	TORNILLO COMBINADO DE CABEZA TRONCOCÓNICA EMPOTRADO EN CRUZ M5x16	CROSS RECESSED PAN HEAD COMBINATION SCREW M5x16		
50	NA	BONKS37-B50	JUEGO DE ENGRASADOR	OILER SET		
51	NA	BONKS37-B51	MOTOR DE GASOLINA	GASOLINE ENGINE		
52	NA	BONKS37-B52	PERNO COMBINADO DE CABEZA HEXAGONAL EMPOTRADA EN CRUZ M6x16	CROSS RECESSED HEX HEAD COMBINATION BOLT M6x16		
53	NA	BONKS37-B53	PERNO COMBINADO DE CABEZA HEXAGONAL EMPOTRADA EN CRUZ M6x20	CROSS RECESSED HEX HEAD COMBINATION BOLT M6x20		
54	NA	BONKS37-B54	MARCO DE SOPORTE DE LA BOMBA	PUMP SUPPORT FRAME		
55	NA	BONKS37-B55	ALMOHADILLA AMORTIGUADORA (ALTO 20)	SHOCK ABSORBING PAD (HIGH 20)		

56	NA	BONKS37-B56	BOMBA DE PLASTICO	PLASTIC PUMP		
57	NA	BONKS37-B57	MANGUERA DE SUCCIÓN	SUCTION HOSE		
58	NA	BONKS37-B58	PINZA ALEMANA 13-19	GERMAN CLAMP 13-19		
59	NA	BONKS37-B59	MUELLE DE ENTRADA DE AGUA 1×9×130	WATER INLET SPRING 1×9×130		
60	NA	BONKS37-B60	MANGUERA DE DESBORDAMIENTO	OVERFLOW HOSE		
61	NA	BONKS37-B61	ABRAZADERA 10-16	CLAMP 10-16		
62	NA	BONKS37-B62	RESORTE DE RETORNO DE AGUA 1×7.5×180	WATER RETURN SPRING 1×7.5×180		





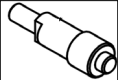



PIEZAS DE LA BOMBA (PUMP PARTS)



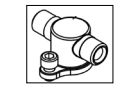

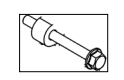
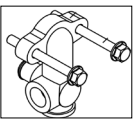
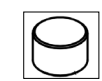
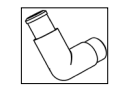
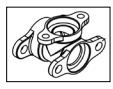









S.NO.	ERP - CODE	BONHOEFFER CÓDIGO	PRODUCTO IN SPANISH	PRODUCTO IN ENGLISH	FOTO DE EMBALAJE	CANTIDAD REQUERIDA
-------	------------	-------------------	---------------------	---------------------	------------------	--------------------











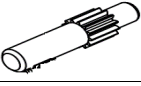

1	NA	BONKS37-P01	INSERTO NO METÁLICO HEX LOCK TUERCA DELGADA M6	NON-METALLIC INSERT HEX LOCK THIN NUT M6		
2	NA	BONKS37-P02	ARANDELA PLANA 6	FLAT WASHER 6		
3	NA	BONKS37-P03	RUEDA REGULADORA	REGULATOR WHEEL		
4	NA	BONKS37-P04	PAPER WASHER 20X10X1.2	PAPER WASHER 20X10X1.2		
5	NA	BONKS37-P05	TUERCA DE PRESILLA	GLAND NUT		
6	NA	BONKS37-P06	JUNTA TÓRICA 14X2.4	O-RING 14X2.4		
7	NA	BONKS37-P07	RETENEDOR DE SELLADO	SEALING RETAINER		
8	NA	BONKS37-P08	VARILLA REGULADORA DE PRESIÓN	PRESSURE REGULATING ROD		
9	NA	BONKS37-P09	TUBERÍA REGULADORA DE PRESIÓN	PRESSURE REGULATING PIPE		
10	NA	BONKS37-P10	JUNTA DE DESBORDAMIENTO	OVERFLOW JOINT		

11	NA	BONKS37-P11	TORNILLO DE CABEZA HUECA HEXAGONAL M6×10	M6×10 HEX SOCKET HEAD CAP SCREW		
12	NA	BONKS37-P12	RESORTE REGULADOR DE PRESIÓN	PRESSURE REGULATING SPRING		
13	NA	BONKS37-P13	ASIENTO DE RESORTE	SPRING SEAT		
14	NA	BONKS37-P14	VÁLVULA DE BOLA	BALL VALVE		
15	NA	BONKS37-P15	ASIENTO DE LA VALVULA DE PRESION	PRESSURE VALVE SEAT		
16	NA	BONKS37-P16	JUNTA TÓRICA 10X1,8	O-RING 10X1.8		
17	NA	BONKS37-P17	CÁMARA DE SALIDA IZQUIERDA	LEFT OUTLET CHAMBER		
18	NA	BONKS37-P18	JUNTA TÓRICA 11X1,9	O-RING 11X1.9		
19	NA	BONKS37-P19	TUERCAS HEXAGONALES	HEX NUTS		
20	NA	BONKS37-P20	PERNO DE ENTRADA DE ACEITE	OIL INLET BOLT		
21	NA	BONKS37-P21	JUNTA TÓRICA 11,8X1,8	O-RING 11.8X1.8		
22	NA	BONKS37-P22	JUNTA TÓRICA 56X2,4	O-RING 56X2.4		
23	NA	BONKS37-P23	CUBIERTA DE LA CAJA DE ENGRANAJES	GEAR CASE COVER		
24	NA	BONKS37-P24	TORNILLO DE CABEZA TRONCOCÓNICA EMPOTRADO EN CRUZ M4×12	CROSS RECESSED PAN HEAD SCREW M4×12		

25	NA	BONKS37-P25	JUNTA TÓRICA 28X2,4	O-RING 28X2,4		
26	NA	BONKS37-P26	ESPEJO DE ACEITE	OIL MIRROR		
27	NA	BONKS37-P27	TUBERÍA DE CONEXIÓN DE SALIDA DE AGUA	WATER OUTLET CONNECTION PIPE		
28	NA	BONKS37-P28	CÁMARA DE SALIDA DERECHA	RIGHT OUTLET CHAMBER		
29	NA	BONKS37-P29	CONJUNTO DE VÁLVULA	VALVE ASSEMBLY		
30	NA	BONKS37-P30	PERNO DE BRIDA HEXAGONAL (MEDIA ROSCA) M6x60	HEXAGON FLANGE BOLT (HALF THREAD) M6x60		
31	NA	BONKS37-P31	RIGHT WATER INLET CHAMBER	RIGHT WATER INLET CHAMBER		
32	NA	BONKS37-P32	ENCHUFAR	PLUG		
33	NA	BONKS37-P33	CODO DE ENTRADA DE AGUA	WATER INLET ELBOW		
34	NA	BONKS37-P34	CÁMARA DE PRESIÓN	PRESSURE CHAMBER		
35	NA	BONKS37-P35	BASE DE APRIETE	TIGHTENING BASE		
36	NA	BONKS37-P36	APRIETE EN FORMA DE V	V- SHAPED TIGHTENING		
37	NA	BONKS37-P37	ANILLO DE APRIETE	TIGHTENING RING		







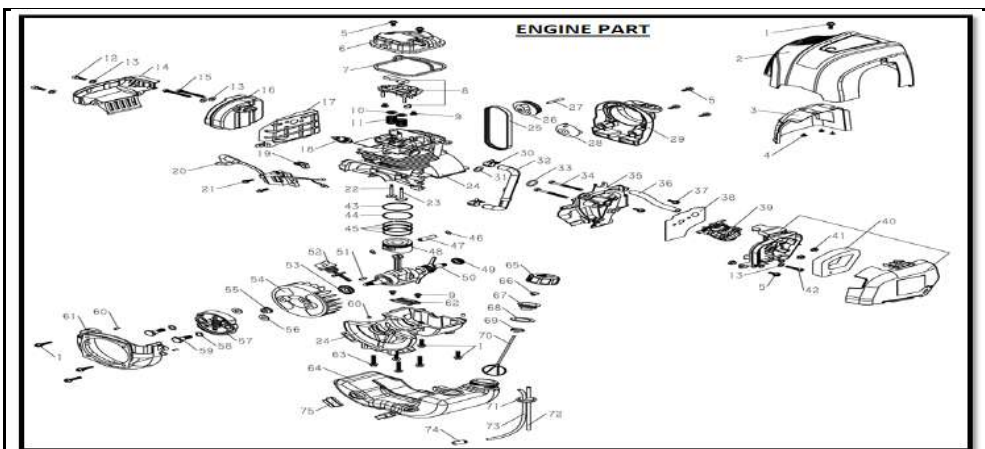

38	NA	BONKS37-P38	EMPAQUETADURA	GASKET		
39	NA	BONKS37-P39	ARANDELA DE FIELTRO	FELT WASHER		
40	NA	BONKS37-P40	SELLO DE ACEITE TIPO FB 17x28x7	FB TYPE OIL SEAL 17x28x7		
41	NA	BONKS37-P41	ÉMBOLO	PLUNGER		
42	NA	BONKS37-P42	CINTURÓN DE ACERO TIPO ARO ELÁSTICO 18	STEEL BELT TYPE ELASTIC HOOP 18		
43	NA	BONKS37-P43	TUBO DE CONEXIÓN DE ENTRADA	INLET CONNECTION PIPE		
44	NA	BONKS37-P44	PERNO DE CABEZA HEXAGONAL M8x10	HEX HEAD BOLT M8x10		
45	NA	BONKS37-P45	JUNTA TÓRICA (EXTERIOR) 9x2	O-RING (OUTER) 9x2		
46	NA	BONKS37-P46	ASIENTO DE LA CAJA DE CAMBIOS	GEAR BOX SEAT		
47	NA	BONKS37-P47	PIN 6X15	PIN 6X15		
48	NA	BONKS37-P48	JUNTA DE SELLADO	SEAL GASKET		
49	NA	BONKS37-P49	RODAMIENTO RÍGIDO DE BOLAS 6200	DEEP GROOVE BALL BEARING 6200		
50	NA	BONKS37-P50	RODAMIENTO RÍGIDO DE BOLAS 6203	DEEP GROOVE BALL BEARING 6203		
51	NA	BONKS37-P51	ENGRANAJE DEL EJE EXCÉNTRICO	ECCENTRIC SHAFT GEAR		















52	NA	BONKS37-P52	RODAMIENTO RÍGIDO DE BOLAS 608	DEEP GROOVE BALL BEARING 608		
53	NA	BONKS37-P53	RODAMIENTO DE AGUJAS	NEEDLE BEARING		
54	NA	BONKS37-P54	PIÑÓN	PINION		
55	NA	BONKS37-P55	RODAMIENTO RÍGIDO DE BOLAS 6201	DEEP GROOVE BALL BEARING 6201		
56	NA	BONKS37-P56	PERNO COMBINADO DE CABEZA HEXAGONAL EMPOTRADA EN CRUZ M6x16	CROSS RECESSED HEX HEAD COMBINATION BOLT M6x16		
57	NA	BONKS37-P57	PERNO COMBINADO DE CABEZA HEXAGONAL EMPOTRADA EN CRUZ M6x20	CROSS RECESSED HEX HEAD COMBINATION BOLT M6x20		
58	NA	BONKS37-P58	TAPA DE CAJA DE CAMBIOS	GEAR BOX COVER		
59	NA	BONKS37-P59	MANGUITO DE SELLO	SEAL SLEEVE		
60	NA	BONKS37-P60	TAMBOR DE EMBRAGUE	CLUTCH DRUM		
61	NA	BONKS37-P61	CÁMARA DE ENTRADA DE AGUA IZQUIERDA	LEFT WATER INLET CHAMBER		





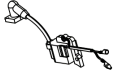







PARTES DEL MOTOR (ENGINE PARTS)















S.NO.	ERP - CODE	BONHOEFFER CÓDIGO	PRODUCTO IN SPANISH	PRODUCTO IN ENGLISH	FOTO DE EMBALAJE	CANTIDAD REQUERIDA
-------	------------	-------------------	---------------------	---------------------	------------------	--------------------











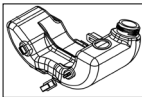

1	NA	BONKS37-E01	TORNILLO DE CABEZA HUECA HEXAGONAL M5x22	HEXAGON SOCKET HEAD FLANGE SCREW M5x22		
2	NA	BONKS37-E02	TAPA DEL CILINDRO	CYLINDER COVER		
3	NA	BONKS37-E03	CUBIERTA SUPERIOR DEL SILENCIADOR	MUFFLER UPPER COVER		
4	NA	BONKS37-E04	TORNILLO DE CABEZA TRONCOCÓNICA EMPOTRADO EN CRUZ ST3.5x8	CROSS RECESSED PAN HEAD TAPPING SCREW ST3.5x8		
5	NA	BONKS37-E05	TORNILLO DE BRIDA DE CABEZA HUECA HEXAGONAL M5x12	HEXAGON SOCKET HEAD FLANGE SCREW M5x12		
6	NA	BONKS37-E06	CUBIERTA DE TAPA DE CILINDRO	CYLINDER HEAD COVER		
7	NA	BONKS37-E07	CYLINDER HEAD COVER SEAL	CYLINDER HEAD COVER SEAL		
8	NA	BONKS37-E08	GRUPO DE PLACAS DE RETORNO DE ACEITE	OIL RETURN PLATE GROUP		
9	NA	BONKS37-E09	TORNILLO DE CABEZA TRONCOCÓNICA EMPOTRADO EN CRUZ M4x8	CROSS RECESSED PAN HEAD SCREW M4x8		

10	NA	BONKS37-E10	ASIENTO DE RESORTE	SPRING SEAT		
11	NA	BONKS37-E11	RESORTE DE VÁLVULA	VALVE SPRING		
12	NA	BONKS37-E12	TORNILLO DE CABEZA HUECA HEXAGONAL M5×16	HEXAGON SOCKET HEAD SCREW M5×16		
13	NA	BONKS37-E13	ARANDELA PLANA 5	FLAT WASHER 5		
14	NA	BONKS37-E14	ESCUDO TÉRMICO DEBAJO DEL SILENCIADOR	HEAT SHIELD UNDER MUFFLER		
15	NA	BONKS37-E15	PERNO DE CABEZA HEXAGONAL M5×45	HEX HEAD BOLT M5×45		
16	NA	BONKS37-E16	SILENCIADOR	MUFFLER		
17	NA	BONKS37-E17	PLACA DE ESCAPE	EXHAUST PLATE		
18	NA	BONKS37-E18	BUJÍA	SPARK PLUG		
19	NA	BONKS37-E19	ABRAZADERA DE CABLE	CABLE CLAMP		
20	NA	BONKS37-E20	ESTATOR DE IGNITION	IGNITION STATOR		
21	NA	BONKS37-E21	TORNILLO COMBINADO DE CABEZA TRONCOCÓNICA EMPOTRADO EN CRUZ M4×16	CROSS RECESSED PAN HEAD COMBINATION SCREW M4×16		
22	NA	BONKS37-E22	VÁLVULA DE ESCAPE	EXHAUST VALVE		
23	NA	BONKS37-E23	VÁLVULA DE ENTRADA	INLET VALVE		

24	NA	BONKS37-E24	GRUPO DE CILINDROS	CYLINDER GROUP		
25	NA	BONKS37-E25	CORREA DE DISTRIBUCIÓN	TIMING BELT		
26	NA	BONKS37-E26	RUEDA DE LEVAS	CAM WHEEL		
27	NA	BONKS37-E27	ÁRBOL DE LEVAS	CAMSHAFT		
28	NA	BONKS37-E28	INICIO DEL CARRETE	START REEL		
29	NA	BONKS37-E29	INICIO	STARTER		
30	NA	BONKS37-E30	ABRAZADERA 13	CLAMP 13		
31	NA	BONKS37-E31	SEALING WASHER 17.4×11×0.8	SEALING WASHER 17.4×11×0.8		
32	NA	BONKS37-E32	TUBO DE RETORNO DE ACEITE EN FORMA DE U	U-SHAPED OIL RETURN PIPE		
33	NA	BONKS37-E33	JUNTA TÓRICA EXTERIOR 18×2,4	O-RING OUTER 18×2.4		
34	NA	BONKS37-E34	PERNO DE CABEZA HEXAGONAL M5×55	HEX HEAD BOLT M5×55		
35	NA	BONKS37-E35	TUBO DE ADMISIÓN	INTAKE PIPE		
36	NA	BONKS37-E36	TUBO DE AIRE DE RETORNO EN FORMA DE S	S-SHAPED RETURN AIR PIPE		

37	NA	BONKS37-E37	TORNILLO CON BRIDA DE CABEZA HUECA HEXAGONAL M5x15	HEXAGON SOCKET HEAD FLANGE SCREW M5x15		
38	NA	BONKS37-E38	JUNTA CARBURADOR	CARBURETOR GASKET		
39	NA	BONKS37-E39	CARBURADOR	CARBURETOR		
40	NA	BONKS37-E40	FILTRO DE AIRE	AIR FILTER		
41	NA	BONKS37-E41	TUERCA HEXAGONAL CON REBORDE M5	HEXAGON FLANGE NUT M5		
42	NA	BONKS37-E42	TORNILLO DE CABEZA HUECA HEXAGONAL M5x25	HEXAGON SOCKET HEAD SCREW M5x25		
43	NA	BONKS37-E43	ANILLO DE PISTÓN I	PISTON RING I		
44	NA	BONKS37-E44	ANILLO DE PISTÓN II	PISTON RING II		
45	NA	BONKS37-E45	ANILLO DE PISTÓN III	PISTON RING III		
46	NA	BONKS37-E46	ANILLO DE SEGURIDAD	CIRCLIP		
47	NA	BONKS37-E47	PASADOR DEL PISTÓN	PISTON PIN		
48	NA	BONKS37-E48	PISTÓN	PISTON		
49	NA	BONKS37-E49	SELLO DE ACEITE 10x20x5	OIL SEAL 10x20x5		
50	NA	BONKS37-E50	CIGÜEÑAL	CRANKSHAFT		

51	NA	BONKS37-E51	LLAVE 3X5X13	KEY 3X5X13		
52	NA	BONKS37-E52	JUEGO DE VARILLAS DE NIVEL DE ACEITE	OIL DIPSTICK SET		
53	NA	BONKS37-E53	SELLO DE ACEITE 15*25*6	OIL SEAL 15*25*6		
54	NA	BONKS37-E54	ROTOR MAGNÉTICO	MAGNETO ROTOR		
55	NA	BONKS37-E55	TUERCA HEXAGONAL CON REBORDE M8	HEXAGON FLANGE NUT M8		
56	NA	BONKS37-E56	ARANDELA PLANA 8	FLAT WASHER 8		
57	NA	BONKS37-E57	CONJUNTO DE EMBRAGUE.	CLUTCH ASSY.		
58	NA	BONKS37-E58	ARANDELA DE RESORTE DE SILLÍN 10	SADDLE SPRING WASHER 10		
59	NA	BONKS37-E59	TORNILLO DE EMBRAGUE	CLUTCH SCREW		
60	NA	BONKS37-E60	PASADOR PARALELO 4*8	PARALLEL PIN 4*8		
61	NA	BONKS37-E61	CARCASA DE MAGNETO	MAGNETO HOUSING		
62	NA	BONKS37-E62	JUEGO DE CAÑAS	REED SET		
63	NA	BONKS37-E63	TORNILLO DE BRIDA DE CABEZA HUECA HEXAGONAL M5*32	HEXAGON SOCKET HEAD FLANGE SCREW M5*32		

64	NA	BONKS37-E64	LATA DE ACEITE	OIL CAN		
65		BONKS37-E65	CUBIERTA PARA LATA DE ACEITE	OIL CAN COVER		
66		BONKS37-E66	BOQUILLA DE ENTRADA	INTAKE NOZZLE		
67		BONKS37-E67	TAPÓN DE ADMISIÓN DEL TANQUE DE ACEITE	OIL TANK INTAKE PLUG		
68		BONKS37-E68	JUNTA DE LA TAPA DE LA OLLA DE ACEITE	OIL POT LID GASKET		
69		BONKS37-E69	FUNDA TRANSPIRABLE PARA OLLA DE ACEITE	OIL POT BREATHABLE COVER		
70		BONKS37-E70	FÉRULA ANTIAPAGADO	ANTI-OFF FERRULE		
71		BONKS37-E71	OLLA DE ACEITE CON DOS OJOS	OIL POT WITH TWO EYES		
72		BONKS37-E72	TUBO DE RETORNO DE ACEITE 3*5*124	OIL RETURN PIPE 3*5*124		
73		BONKS37-E73	TUBO DE ENTRADA DE ACEITE 3*5,5*162	OIL INLET PIPE 3*5,5*162		
74		BONKS37-E74	FILTRO DE SUCCIÓN DE ACEITE	OIL SUCTION FILTER		
75	NA	BONKS37-E75	AMORTIGUADOR ENGRASADOR	OILER SHOCK ABSORBER	